



apw

IMRAK® 610

Multiplatform cabinet

IMRAK® 610

Overview

Material specification

- **Top cover:**
1.2 mm steel
- **Bottom cover:**
1.2 mm steel
- **Cable entry plates:**
1.2 mm steel
- **Glass door:**
1.0 mm steel, 4.0 mm toughened, tinted, glass
- **19" panel mount:**
2.0 mm steel
- **IMRAK® 610 load capacity:**
250 Kg

Standards

IEC 60297: Dimensions for mechanical structures of the 482.6 mm (19") series

DIN 41494: Basic specification for the 19" construction systems

EN 60950: European standard for safety of information technology equipment

VDE 0100: Selection and Set up of current systems and earthing

DIN-1249-11: Glass in building; glass edges

Colour specification



RAL 7016
with blue trims

Dimensions

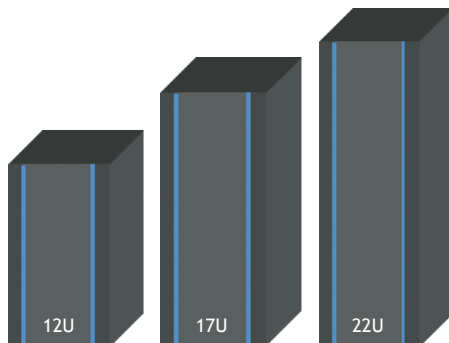

Floor version

Depth 600 - 800 mm

Width 600 mm

Introduction to IMRAK® 610

IMRAK® 610 is a mid size floor standing enclosure particularly suitable for networking applications and 19" equipment housing in office or industrial locations. With a height range of 12U to 22U, designed to fit underneath desks and work surfaces.

IMRAK® 610 has a welded frame construction giving it strength and security. It has a rated 250kg load capacity. There is a choice of reversible steel or glass front doors. The rear panel has a latch for easy opening and closing. The side panels are non-removable. Cable access is through the base or the ventilated top cover. Two removable plates are fitted to the top cover, allowing for cable access. Alternatively, one or two optional two-fan units can be fitted in the roof without intruding into the useable height. Standard or intelligent 19" fan trays can also be mounted within the enclosure for additional cooling.

The 19" panel mountings are depth adjustable to allow for different sizes of active equipment to be added, or to give as much space as is required in front of the panels for patching applications. Shelves and cases are fitted to the frame with the same "no fixing" hook-in design used in the larger IMRAK® cabinets, reducing time assembly during the configuration.

IMRAK® 610 shares with the IMRAK® family a common interchangeable set of accessories and fittings. It also follows the same design and colour scheme. The IMRAK® 610 is supplied fully assembled. With a single code ordering a standard rack is made easy by just specifying the height, plan size and choice of doors.



Key Features:

- 3 height options: 12U, 17U and 22U
- 2 depth options: 600 mm and 800 mm
- Load capacity: 250 Kg
- Steel or glass lockable front door with quick-release reverse facility
- Standard adjustable front 19" panel mounts
- Top and base gland plates provide cable access
- Natural ventilation through vented slots at top and base
- Optional zero-U roof-mounted fan tray
- Vast selection of application specific accessories

Technical specifications

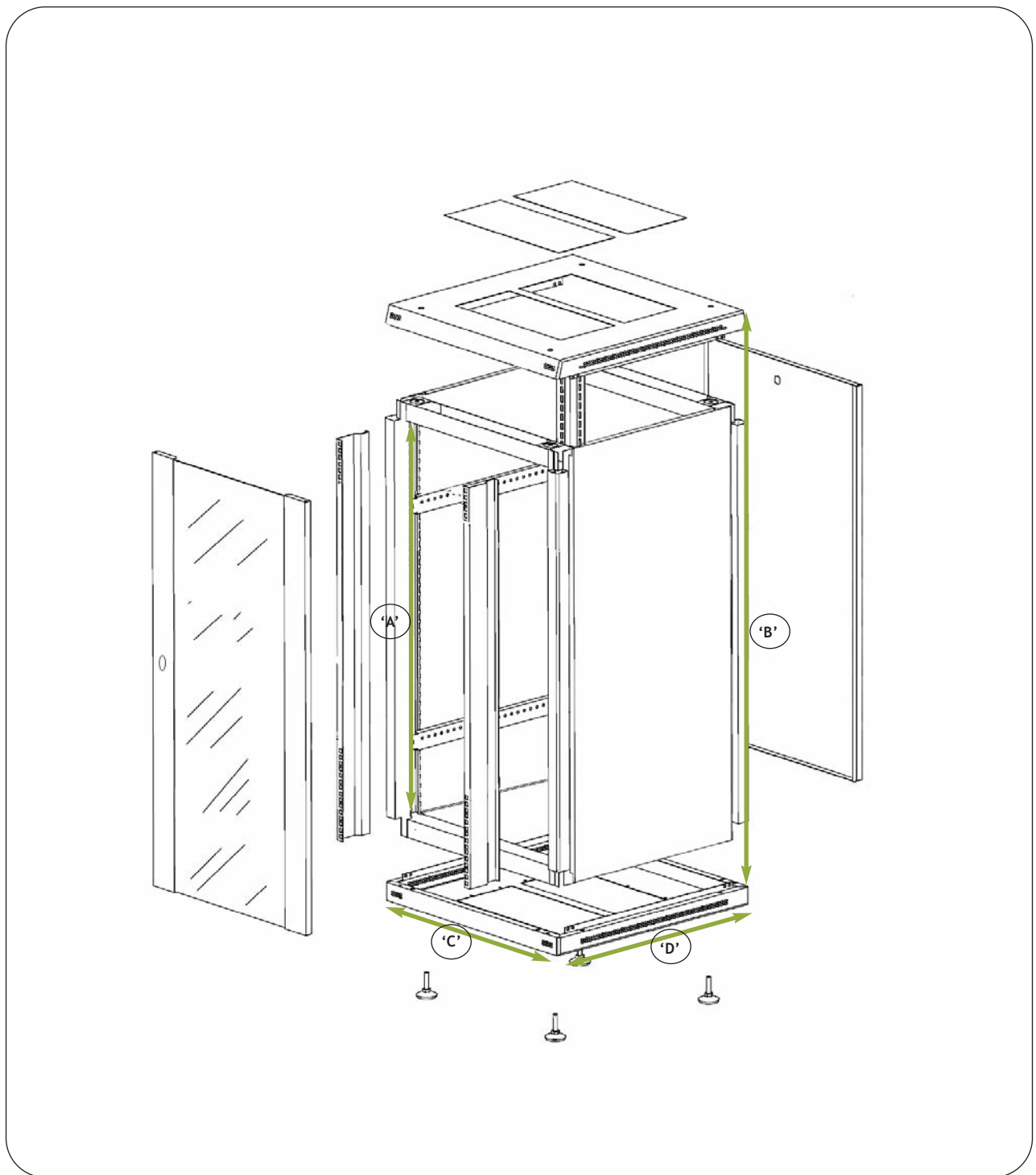

'A' = Internal height	Unit height	'B' = Total height	'C' = Width	'D' = Depth
542,9	12U	664,4	600	600 / 800
765,15	17U	886,65	600	600 / 800
987,4	22U	1108,9	600	600 / 800

IMRAK® 610 Primary

The IMRAK® 610 Primary is a ready configured enclosure, pre-equipped with a lockable front door, a rear panel with latch opening, front 19" panel mounts, two pairs of panel mount supports, top gland plates and adjustable feet. It can also be used as the starting point for creating a unique enclosure with the use of additional accessories.

Contents of kit	Qty
Open frame	1
Glass front door	1
Rear panel	1
Top cover for plate	2
19" panel mounts	1 pair
Panel mount supports	2 pair
Adjustable feet	1 kit

Ordering information

Primary front door in glass

Height	Width	Depth	Order code
12U	600 mm	600 mm	VS384-775332
12U	600 mm	800 mm	VS384-775338
17U	600 mm	600 mm	VS384-775333
17U	600 mm	800 mm	VS384-775339
22U	600 mm	600 mm	VS384-775334
22U	600 mm	800 mm	VS384-775340

Primary front door in steel

Height	Width	Depth	Order code
12U	600 mm	600 mm	VS386-775667
12U	600 mm	800 mm	VS386-775670
17U	600 mm	600 mm	VS386-775668
17U	600 mm	800 mm	VS386-775671
22U	600 mm	600 mm	VS386-775669
22U	600 mm	800 mm	VS386-775672

There is a vast range of IMRAK® 610 accessories in order to create your own unique enclosure. Please request the IMRAK® 610 specification guide.



IMRAK® 610
special version with rear door
and lateral ventilation

IMRAK® 610

Structural elements

Frame

Fully welded. The (non-removable) side panels with the top and bottom covers form the structure.

Panel mounts

Supplied with 2, 19" fontal panel mounts.

Front doors

Front door is supplied in two options, metal or strengthened glass. Swing handle are available oupon request with manual or automatic lock.

Swing handle

Can be supplied as option for both glass or metal doors. A manual or automatic lock is available upon request.

Top cover

The top cover is latterly ventilated for natural air flow. Two cable entry areas with gland plate are available as standard. The same area can host 2 ventilating fans and maintain a clear path for cables.

Bottom

The bottom is open to offer a wider cable entry area.



Frame

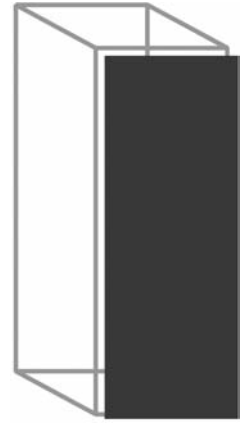

Metal door

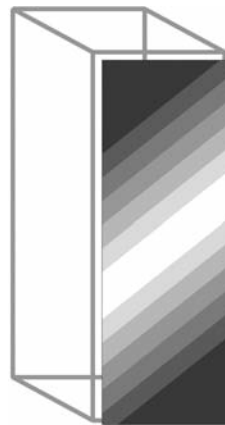

Glass door

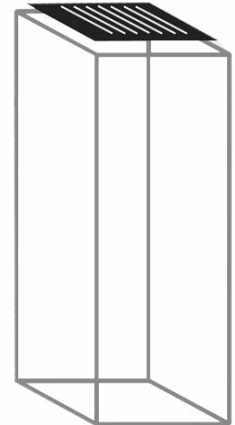

Top cover

Thermal kit

Description	Order code
Thermal kit 2 fans (half)	VK385-775532
Thermal kit 4 fans (full)	VK385-775828
Thermal kit 2 fans low noise (half)	VK385-775895
Thermal kit 4 fans low noise (full)	VK385-775896

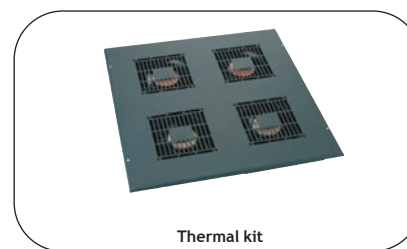

Thermal kit

Entry panel kit

Description	Order code
Cable entry panel with brush	VK385-775535
Cover partial / full	VK385-775629
Cover partial / ventilated	VK385-775727



Cable entry panel with brush

Castors kit

Description	Order code
Light/medium duty castors kit - 80 Kg static load braked	VK385-775721
Light/medium duty castors kit - 80 Kg static load unbraked	VK385-775722
Heavy duty castors kit - 115 Kg static load 2 braked	VK385-776250
Heavy duty castors kit - 115 Kg static load 2 unbraked	VK385-776251



Castors kit

Fixed shelves kit - Load reating 100 Kg

Description	Order code
370 mm deep fixed shelves kit (600/800 deep version)	VK385-776192
470 mm deep fixed shelves kit (600/800 deep version)	VK385-775730
570 mm deep fixed shelves kit (800 deep version)	VK385-776194
670 mm deep fixed shelves kit (800 deep version)	VK385-775732



Fixed shelves kit

19" Cantilever shelves

Description	Order code
255 mm deep 19" cantilever shelves kit	VK593-599790
400 mm deep 19" cantilever shelves kit	VK593-599791



19" cantilever shelves

19" Cantilever sliding keyboard

Description	Order code
19" cantilever sliding keyboard shelves kit	VK385-775709



19" cantilever sliding keyboard

Accessories

Thermostat and wiring kit

Description	Order code
Thermostat and wiring kit	VK385-775843

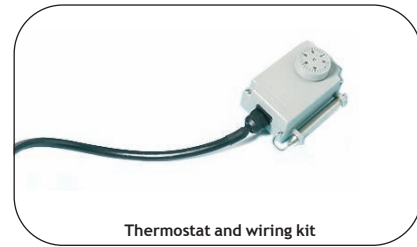

Thermostat and wiring kit

Chassis support

Description	Order code
370 mm chassis support kit	VK385-776268
470 mm chassis support kit	VK385-775952
570 mm chassis support kit	VK385-776252

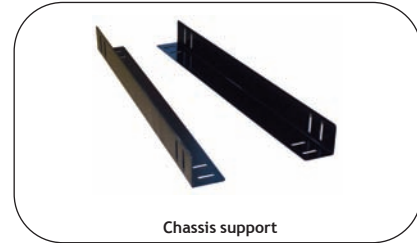

Chassis support

Single and double cable hoops kit

Description	Order code
Double cable metal hoops kit of 10	VK385-775723
Single cable metal hoops kit of 10	VK385-775724
Single cable plastic hoops kit of 10	VK385-776232



Cable support kit with hooks

Cable management panels kit

Description	Order code
1U 19" cable management panel w/metal hoops	VK385-776196
1U 19" cable management panel w/plastic hops	VK385-776229

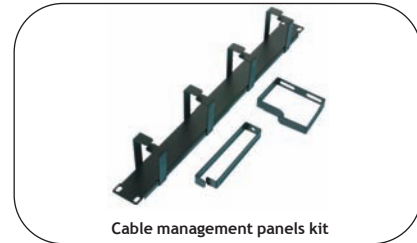

Cable management panels kit

Caged nuts and fixings

Description	Order code
M6 caged nuts kit 50 pz.	VK385-776190
M6 x 12mm pozzi drive screws and cup washers kit 50 pz.	VK385-776191

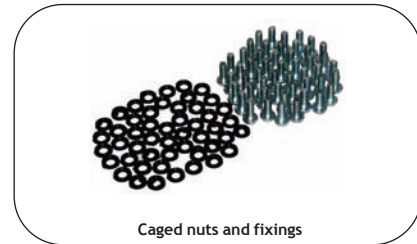

Caged nuts and fixings

Earth continuity kit

Description	Order code
Earth continuity kit	VK385-775726



Earth continuity kit

Active Rack Controller (ARC)

Description	Order code
ARC 19" 1U w/temperature/humidity sensors and software	N/A
Active Rack Controller Top version with temperature/humidity sensors and software	N/A
Smoke detector	N/A
Shock sensor	N/A
Door sensor (open/close)	N/A
Electronic handle w/ keyboard and electric lock	N/A
Sound sensor	N/A
Electric lock	N/A
Badge reader	N/A
Keypad	N/A

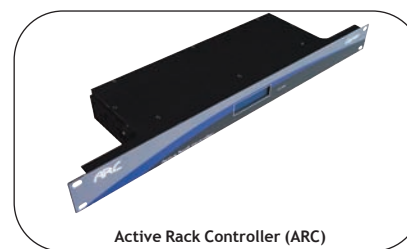

Active Rack Controller (ARC)

Fire Protection Unit (FPU)

Description	Order code
Unit Master FPU w/ smoke detector and GAS FM200 for 1,5m	VA295-000000
Unit Slave FPU w/ smoke detector and GAS FM200 for 1,5m	VA295-000001



Fire Protection Unit (FPU)

Accessories

Network Power Manager

Steel Network Power Manager

1U - 19" rackmount	Order code
PDU 4 sockets multistandard w/illuminated switch	K04MET-IL2S
PDU 4 sockets multistandard w/MGT	K04MET-MT2S
PDU 4 sockets multistandard no protection	K04MET-SI2S
PDU 6 sockets multistandard w/illuminated switch	K06MET-IL2S
PDU 6 sockets multistandard w/MGT	K06MET-MT2S
PDU 6 sockets multistandard no protection	K06MET-SI2S
PDU 9 sockets multistandard w/illuminated switch	K09MET-IL2S
PDU 9 sockets multistandard w/MGT	K09MET-MT2S
PDU 9 sockets multistandard no protection	K09MET-SI2S

Also available in 1U 19" up to 16 IEC sockets.



Plastic Fireproof Network Power Manager

1.5U - 19" rackmount	Order code
PDU 5 multistandard socket w/MGT	C5NER-MSTDB
PDU 5 UK sockets w/illuminated switch, 13A BS1363 Plug	CL05-UKIL13ABS
PDU 6 multistandard socket w/illuminated switch	C6NER-MSTVI
PDU 6 UK sockets w/MGT, 13A BS1363 Plug	CL06-UKMT13ABS

2U - 19" rackmount	Order code
PDU 20 IEC socket w/MGT, 16A DIN49441 Plug	CL20-IECMT16AD

Vertical mounting	Order code
PDU 12 multistandard socket w/MGT	C12NE-MSTDBPC
PDU 12 UK style socket w/MGT, 13A BS1363 Plug	CL12-UKMT13ABS
PDU 12 IEC style socket w/MGT, 16A DIN49441 Plug	CL12-IECMT16AD

Power Distribution Units are CE marked - conforms to CEI EN 60439-1 regulation



Multistandard PDU

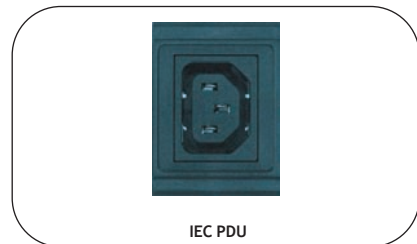

IEC PDU



DIN49441 plug



BS1363 plug